

FERYSTER

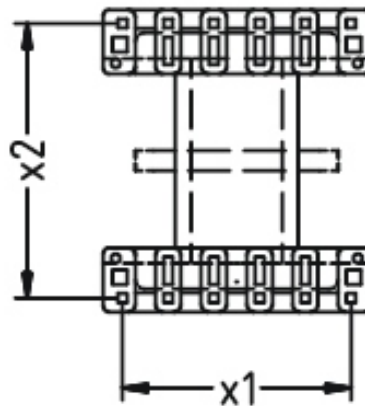
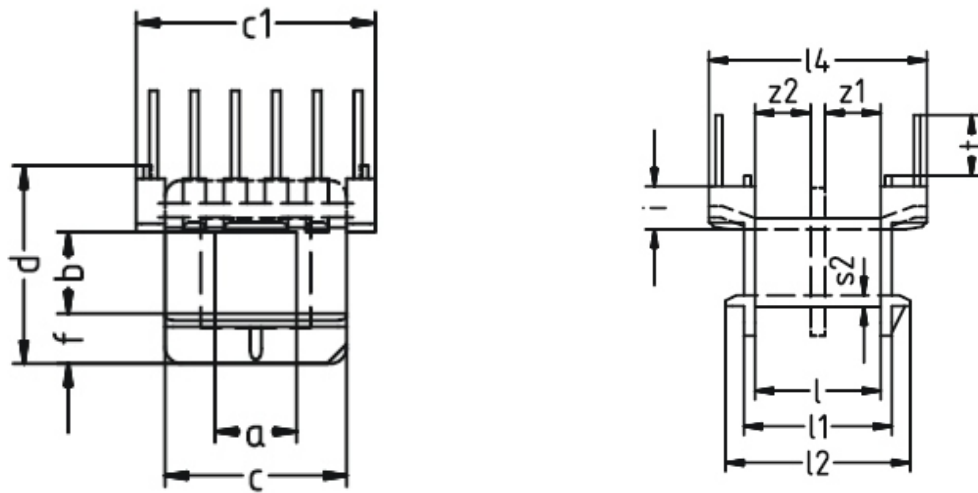

a	b	c	c1	d	f	i	l	l1	l2	l4	s2	z1	z2	x1	x2	x3	t
4,9	4,9	11,1	14,6	12,2	3,1	3,4	9,5	11,1	14,0	16,4	0,8	-	-	5x2,5	15,0	12	4,6